

FLEXIFOLD 8 PAGE

**INSTALLATION, OPERATION,
&
PARTS MANUAL**

© 2003 Baumfolder Corporation
All Rights Reserved

WARNING

- Do not operate this machine without all guarding in place.
- Do not make adjustments or perform maintenance on this machine with power on.
- Keep the machine and the work area clean and free of spills to prevent accidents.
- Be sure to replace any safety decals that may have been detached for any reason.

BAUMFOLDER reserves the right to make changes in design or to make additions or improvements in its products without imposing any obligation upon itself to install them on its products previously manufactured. It is recommended that modifications to this equipment not be made without the advice and express written consent of BAUMFOLDER.

FOLDER IDENTIFICATION

MODEL NO: _____ SERIAL NO: _____

DEALER : _____

INSTALLED BY: _____ DATE: _____

PHONE NO: _____

TABLE OF CONTENTS

FUNDAMENTAL SAFETY INSTRUCTIONS	5
1.0 INTRODUCTION	9
2.0 SPECIFICATIONS	9
3.0 INSTALLATION	9
3.1 Unpacking & Inspection	9
4.0 ASSEMBLY	10
4.1 Main Unit	10
4.2 Transfer Table	10
4.3 Delivery Table	10
4.4 Cross Carrier Assembly Installation	10
4.5 Fold Plate Installation	10
5.0 ELECTRICAL ACCESS	11
6.0 OPERATION	11
6.1 The Main Power/Reset Switch	11
6.2 Starting the Production Job	11
6.3 Check Squareness of Fold	11
6.4 Use Of Handwheel	12
7.0 OPERATOR PANEL	12
7.1 Button Identification (2nd Function).....	12
8.0 START UP	13
9.0 SETUP	13
9.1 Setup for a Standard Fold	13
9.2 Setting Up a Special Fold	15
9.2.1 To Save a Non-Standard Fold in a Memory Location	15
9.2.2 Recall a Fold Saved in Memory Location	15
9.3 Starting the Production	15

TABLE OF CONTENTS

10.0 COUNTER OPERATION	16
10.1 Resetting the Total Count	16
10.2 Rate	16
11.0 FOLDER OPERATION	17
11.1 Time	17
11.2 Start/Stop Button	17
11.3 Speed	18
11.4 Fold Plates	18
11.5 Stacker Wheels	19
11.6 Paper Jams	20
11.7 Shutting Off Jam Detectors	20
12.0 PERFORATING, SCORING & SLITTING	22
12.1 Perforating	22
12.2 Scoring	23
12.3 Slitting	23
13.0 MAINTENANCE	24
13.1 Maintenance and Care of your Flexifold	24
13.2 Cleaning of Fold Rolls	24
13.3 Cleaning Filters	24
13.4 Photo Eyes	24
13.5 Cleaning The Fold Stop Guides	24
13.6 Replacement Parts	24
14.0 LANGUAGE SELECTION	25
15.0 DISPLAY MESSAGES	26
16.0 MATERIAL SAFETY DATA SHEET	27
17.0 BASIC THEORY OF BUCKLE FOLDING	28
18.0 PARTS SECTION

FUNDAMENTAL SAFETY INSTRUCTIONS!

The diagrams and descriptions used in these instructions are not necessarily applicable to the specification of the machine supplied. Modifications, made for reasons of technical or operational improvement, are embodied without notice.



FUNDAMENTAL SAFETY INSTRUCTIONS!

These operating instructions are designed to familiarize the user with the machine and its designated use.

The instruction manual contains important information on how to operate the machine safely, properly and most efficiently. Observing these instructions helps to avoid danger, to reduce repair costs and downtimes and to increase the reliability and life of the machine.

In addition to the operating instructions and to the mandatory rules and regulations for accident prevention and environmental protection in the country and place of use of the machine, the generally recognized technical rules for safe and proper working must also be observed.

The following signs and designations are used in the manual to designate instructions of particular importance.

-  **Important**
(refers to special information on how to use the machine/plant most efficiently)
-  **Attention**
(refers to special information and/or orders and prohibitions directed towards preventing damage)
-  **Danger**
(refers to orders and prohibitions designed prevent injury or extensive damage)

1.0 Basic operation and designated use of the machine/plant

1.0.1

The machine has been built in accordance with state-of-the art standards and the recognized safety rules. Nevertheless, its use may constitute a risk to life and limb of the user or of third parties, or cause damage to the machine and to other material property.

1.0.2

The machine must only be used in technically perfect condition in accordance with its designated use and the instructions set out in the operating manual, and only by safety-conscious persons who are fully aware of the risks involved in operating the machine. Any functional disorders, especially those affecting the safety of the machine, should therefore be rectified immediately.

1.0.3

The machine/installation is designed exclusively for paper finishing of minimum and maximum sheet sizes (see corresponding operating instructions). Using the machine/installation for purposes other than those mentioned above is considered contrary to its designated use. The manufacturer/supplier cannot be held liable for any damage or injury arising from such misuse. The risk of such misuse lies entirely with the user.

Operating the machine within the limits of its designated use also involves observing the instructions set out in the operating manual and complying with the inspection and maintenance directives. The working temperature of the machine should range between 0° and 55° C.

1.1 Organizational measures

1.1.1

The operating instructions must always be at hand at the place of use of the machine, e.g. by stowing them in the tool compartment or tool-box provided for such purpose.

1.1.2

Personnel entrusted with work on the machine must have read the operating instructions and in particular the chapter on safety before beginning work. Reading the instructions after work has begun is too late. This applies especially to persons working only occasionally on the machine, e.g. during setting up or maintenance.

1.1.3

For reasons of security, long hair must be tied back or otherwise secured, garments must be close-fitting and no jewelry - such as rings - may be worn. Injury may result from being caught up in the machinery or from rings catching on moving parts.

1.1.4

Observe all safety instructions and warnings attached to the machine.

1.1.5

See to it that safety instructions and warnings attached to the machine are always complete and perfectly legible.

1.1.6

In the event of safety-relevant modifications or changes in the behaviour of the machine during operation, stop the machine immediately and report the malfunction to the competent authority/person.

1.1.7

Never make any modifications, additions or conversions which might affect safety without the supplier's approval. This also applies to the installation and adjustment of safety devices and valves as well as to welding work on load-bearing elements.

1.1.8

Spare parts must comply with the technical requirements specified by the manufacturer. Spare parts from original equipment manufacturers can be relied to do so.

1.1.9

Report any accident that occurs due to a malfunction of the machine though all prescribed safety precautions were observed directly to our agency or to the Baumfolderservice department.

1.2 Selection and qualification of personnel - Basic responsibilities

1.2.1

Employ only trained or instructed staff and set out clearly the individual responsibilities of the personnel for operation, set-up, maintenance and repair.

1.2.2

Make sure that only authorized personnel works on or with the machine.

1.2.3

Work on the electrical system and equipment of the machine must be carried out only by a skilled electrician or by instructed persons under the supervision and guidance of a skilled electrician and in accordance with electrical engineering rules and regulations.

1.2.4

Work on gas fueled equipment (gas consumers) may be carried out by specially trained personnel only.

1.3 Safety instructions governing specific operational phases

1.3.1 Standard operation

1.3.1.1

Avoid any operational mode that might be prejudicial to safety.

1.3.1.2

Take the necessary precautions to ensure that the machine is used only when in a safe and reliable state. Operate the machine only if all protective and safety-oriented devices, such as removable safety devices, emergency shut-off equipment, sound-proofing elements and exhausters, are in place and fully functional.

1.3.1.3

Check the machine at least once per working shift for obvious damage and defects. Report any changes (incl. changes in the machine's working behaviour) to the competent organization/person immediately. If necessary, stop the machine immediately and lock it.

1.3.1.4

Before starting up or setting the machine in motion, make sure that nobody is at risk.

1.3.2

Special work in conjunction with utilization of the machine and maintenance and repairs during operation; disposal of parts and consumables.

1.3.2.1

Always press the emergency (Not-Stop) button first, if you stop the machine for adjustments or maintenance work which must not be done while the machine is in operation.

1.3.2.2

For extensive maintenance or repair work, turn off the main power supply.

1.3.2.3

After making adjustments or after doing maintenance or repair work, always make sure that all tools or other objects are removed from the machine. Otherwise they might fall into the machine, causing severe damage or injuries.

1.3.2.4

Keep the floor around the entire machine clean. Immediately clean any oil, grease or paint spills up off the floor. Remove tools, cleaning cloths or paper scraps from all work areas.

1.3.2.5

Never operate a folding machine without buckle plates or deflectors since these are protective as well.

1.3.2.6

Never clean moving parts of the machine (rollers, shafts) or remove any test sheets, spoiled sheets or bits of paper in such areas.

1.3.2.7

Observe the adjusting, maintenance and inspection activities and intervals set out in the operating instructions, including information on the replacement of parts and equipment. These activities may be executed by skilled personnel only.

1.3.2.8

Brief operating personnel before beginning special operations and maintenance work, and appoint a person to supervise the activities.

1.3.2.9

If the machine is completely shut down for maintenance and repair work, it must be secured against inadvertent starting by:

- locking the principal control elements and removing the ignition key and/or
- attaching a warning sign to the main switch.

1.4.1 Electric energy

1.4.1.1

Use only original fuses with the specified current rating. Switch off the machine/plant immediately if trouble occurs in the electrical system.

1.4.1.2

If provided for in the regulations, the power supply to parts of machines and plants, on which inspection, maintenance and repair work is to be carried out must be cut off. Before starting any work, check the de-energized parts for the presence of power and ground or short-circuit them in addition to insulating adjacent live parts and elements.

1.4.1.3

The electrical equipment of machines is to be inspected and checked at regular intervals. Defects such as loose connections or scorched cables must be rectified immediately.



Warning!

Be careful! Height adjustment devices might cause bruising!

1.4.1.4

Necessary work on live parts and elements must be carried out only in the presence of a second person who can cut off the power supply in case of danger by actuating the emergency shut-off or main power switch. Secure the working area with a red-and-white safety chain and a warning sign. Use insulated tools only.



Warning!

Only operate machine when covers are closed.

1.4.1.5

Only unplug or plug electrical connectors if the main switch has been disconnected.

1.6 Explanation of the pictographs used in the operating instructions

1.4.1.6

Only connect the folding units and no machines of other brands to the existing connectors. Any electrical connection of BAUMFOLDER folding machines with other brands needs our express consent.



Warning!

You might risk bruising when moving the machine.

1.4.1.7

For electrical connection, observe the prescribed admissible voltage and frequency.

1.4.1.8

Keep switch cabinets closed.

1.4.2

Oil, grease and other chemical substances

1.4.2.1

When handling oil, grease and other chemical substances, observe the product-related safety regulations.

1.5 Description and definition of the safety labels and pictographs on the machine

Replace damaged pictographs by new ones. The corresponding reference numbers are indicated.



Warning!

Folding rollers rotate in opposite directions. Keep hands away from rollers while the machine is running!



Warning!

To avoid bruising, keep hands away when operating moving machine parts!



Warning!

Do not reach into moving belts!

1.0 INTRODUCTION

Your new Flexifold 8 Page Modular Folder has been designed to give you many years of useful service provided it is installed, maintained, and operated according to the instructions in this manual.

Your Flexifold 8 Page is a unique and versatile paper folding machine, capable of folding paper measuring between 3 x 5 inches (7.6 x 12.7 cm) and 14 x 20 inches (35.5 x 50.8 cm), at speeds up to 27,600 sheets per hour of 8 1/2 x 11 (21.6 x 27.9 cm) and up to 41,000 sheets per hour of 3x5 (7.6x12.7 cm). The Flexifold can make four types of folds: single fold, letter fold, fan fold, double-parallel fold, with the push of a button. (Note: There are also three (3) memory locations for special folds that you may require).

2.0 SPECIFICATIONS

Model No	Flexifold 8 Page
Minimum Sheet Size	3 x 5" (7.6 x 12.7 cm)
Maximum Sheet Size	14 x 20" (35.5 x 50.8 cm)
Minimum Size Fold	2 " (5.1 cm)
Maximum Paper Weight	65 lb. Cover
Fold Roll Speed	Infinitely variable between 1900"/min. and 7200"/min. (18,288 cm/min. or 182 m/min.)
Fold Plate Depth	#1 Plate, 13.5" (34.3 cm) #2 Plate, 13.5" (34.3 cm)
Fold Roll Width	14 1/8" (35.8 cm)
Fold Roll Diameter	1 1/2" (3.8 cm)
Overall Dimensions	Height 53" (134.6 cm) Length 64" (162.6 cm) Width 28" (71.1 cm)
Operating Voltage	110 VAC/1PH/60Hz
Power Consumption (folder)	350 Watts
Amperage (total)	3.5 Amp
Supplied power	115VAC +/-10% 60HZ, 15AMP
Mating Connector	NEMA 5-15R

3.0 INSTALLATION

3.1 Unpacking & Inspection

The Flexifold Air Feed is packaged in three cartons, crated together as one package. It is broken down into 8 major assemblies for shipment. These are:

- A) Main Folder Assembly
- B) Cross Carrier
- C) Mobile Stand
- D) Accessory Package
- E) Transfer Table
- F) Fold Pans (2)
- G) Documentation Package
- H) 1/2 Pint Surewash

NOTICE

Immediately upon unpacking, carefully inspect each of the above assemblies for shipping damage. If any damage is found, be sure to contact the delivery freight carrier to file a damage claim. Save all packaging material for the claims adjustor to inspect.

WARNING

Do not plug the power cord into an AC outlet until the Flexifold 8 Page is fully assembled, adjusted and ready to use. Unplug the Flexifold any time disassembly is required.

4.0 ASSEMBLY

4.1 Main Unit

To assemble the Flexifold 8 Page unit, first remove the four bolts holding it to the skid. Place the folder on the stand (See Figure 4.1-1).

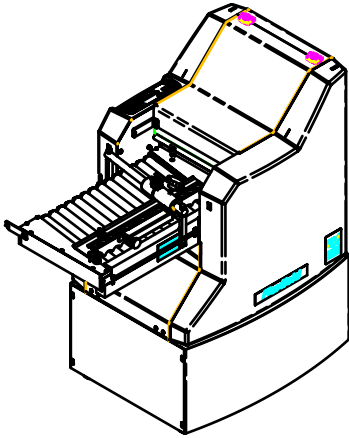

Figure 4.1-1

4.2 Transfer Table Mounting

Before mounting the transfer table into the first unit, mount the 35T gear (FK0000824) from the accessory kit, on the lower splitter shaft. Gear to be located with the hub against the bearing race on the left hand side of the folder and tighten the two set screws. (Guard removed for clarification) See Figure 4.2-1.

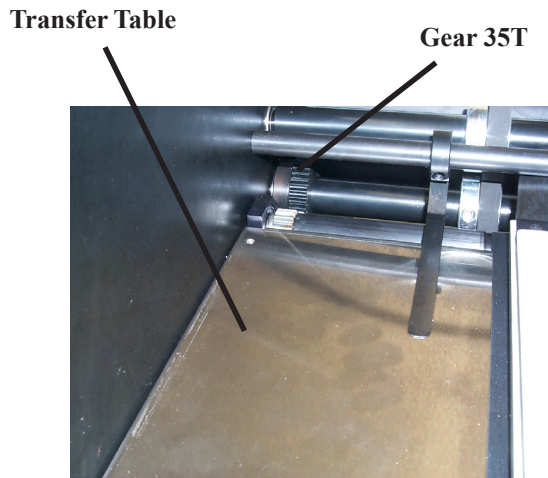

Figure 4.2-1

4.3 Delivery Table

To install the delivery table, insert the delivery table with the drive wheel toward the fold rolls. Slide the delivery table over both sets of locating pins.

The first notch in the front part of the delivery table should rest on the pins. Then drop the rear notch down on the rear dowel pins.

Rotate the handwheel to check that the gears are properly meshed.

Plug the delivery table into the table receptacle on the input/output power assembly.

4.4 Cross Carrier Assembly Installation

Insert the Cross Carrier with the gears toward the fold rolls. Slide the Cross Carrier table over both sets of locating pins.

The first notch in the front part of the Cross Carrier should rest on the pins. Then drop the rear notch down on the upper dowel pins.

Rotate the handwheel to check that the gears are properly meshed.

4.5 Fold Plate Installation

WARNING

Unplug the AC power cord when installing or removing fold plates.

The fold plates are interchangeable.

Each fold plate has an open end which faces toward the fold rolls.

To install the fold plates, pivot the fold plate hold-downs out of the way and slide the fold plate in position so that the slots in the leading edge of the fold plate engage the two locating pins in the side frames.

The center notches should seat on the second set of locating pins. Pivot the fold plate hold-downs back into position to secure the fold plates.

Turn the handwheel to be sure that the fold plates are properly installed and not rubbing on the fold rolls.

Plug the fold pan connectors into the side frame. (See figure 4.5-1)



Figure 4.5-1

5.0 ELECTRICAL ACCESS

WARNING

Turn off the main power switch(See figure 5.0-1). Unplug the AC power cord before attempting any electrical repair.

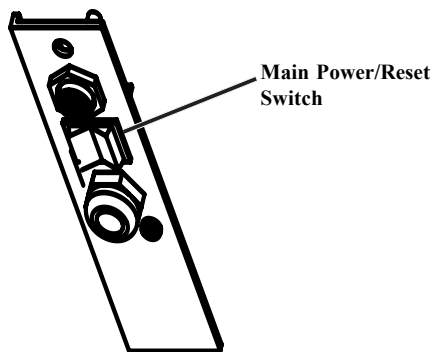

Figure 5.0-1

The electrical controls are located in the left-hand side cover. The handwheel must be removed for access to these controls.

The cover can be removed by taking out the four screws located on the inside of the frame.

6.0 OPERATION

6.1 The Main Power/Reset Switch

The main power/reset switch (Figure 6.1-1) will completely shut off all power to the operating system. This will stop everything immediately.

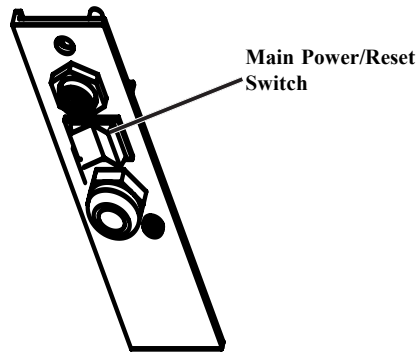

Figure 6.1-1

6.2 Starting the Production Job

The production job may be started after preparing the folder by:

- Setting the sheet size
- Loading the feed table
- Selecting the fold type
- Setting Cross Carrier Side Guide

Folding may be stopped by pressing the “SHEET START” button a 2nd time on the Parallel Unit.

6.3 Check Squareness of Fold

Examine the folded sheets on the stacker to make sure that you are getting an even and square fold.

There is a skew adjustment on each plate to adjust for a square fold on paper that is not cut square (See figure 6.3-1).

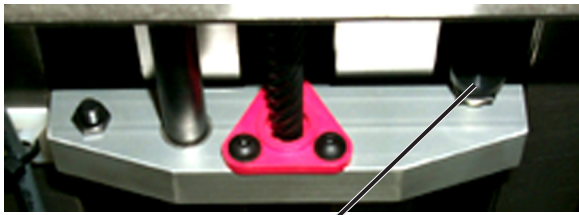

Fold Stop Guide

Figure 7.4-1

6.4 Use of Handwheel

The handwheel is used to help clear jams and for setup. To use the handwheel, shut off the folder, pull out the handwheel and turn it in either direction.

7.0 OPERATOR PANEL

7.1 Button Identification (2nd function)

01)	Count Select, (#1)	16)	Function Reset
02)	Rate Select, (#2)	17)	Inches/Metric Unit Select
03)	Time Select, (#3)	19)	Sheet Mode Select
04)	Speed Adjust, (#4)	20)	Alphanumeric Display
05)	Plate #1 Adjust, (#5)	23)	Folder Drive Start/Stop
06)	Plate #2 Adjust, (#6)	24)	Letter Fold Select
07)	Memory 1 Set, (#7)	25)	Z-fold Select
08)	Memory 2 Set, (#8)	26)	Double Half-fold Select
09)	Memory 3 Set, (#9)	27)	Half-fold Select
10)	Sheet Jam Select, (#0)		
11)	Stacker Adjust		
13)	Data Enter	30)	Operator Control Panel
14)	Decrement		
15)	Increment		

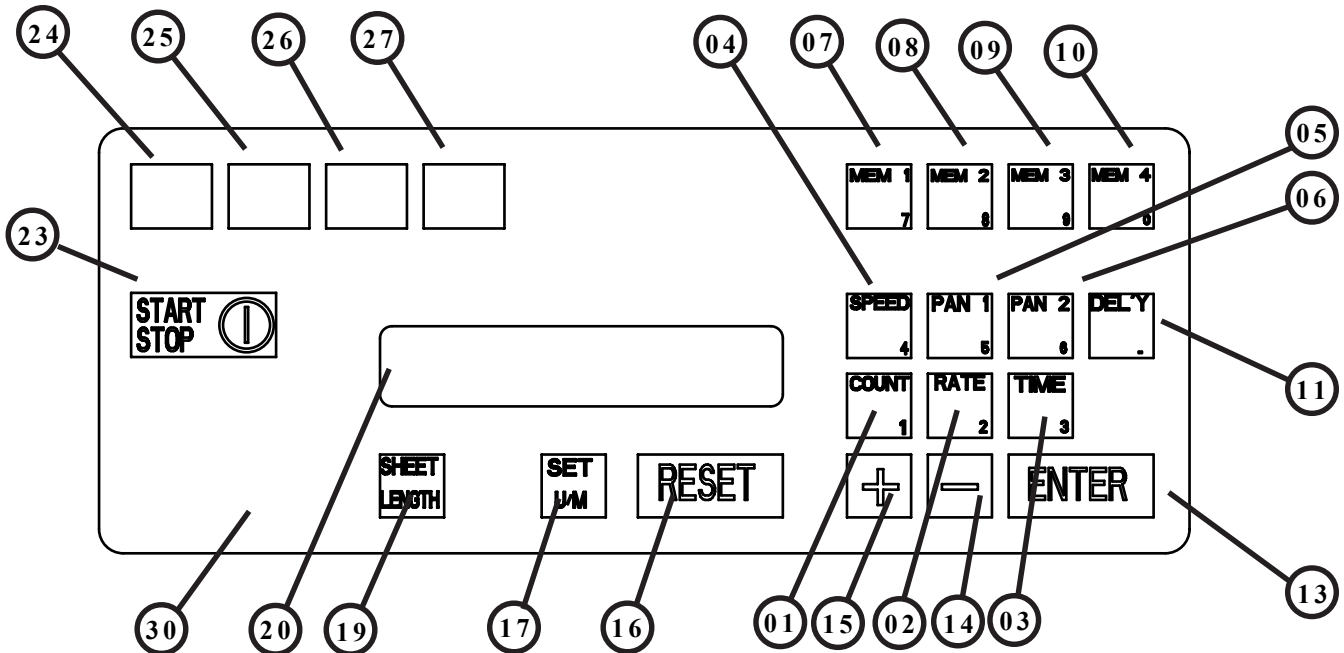

8.0 START UP

When power is applied, the system will first test all LEDs, memory and display characters for 3 seconds.

After the self diagnostic phase, the display will show the version number for 3 seconds.

If there are no error messages the display will go to the jam detector screen if one of the jam detectors is disabled. If none are disabled or after depressing enter, the display will go to the initialization screen.

The initialization screen will remain for 10 seconds. If the “+” button is not pressed during this time no initialization will occur. The display will go to the count screen.

If there is any question about folding accuracy, re-initialize the system by turning off the power, then turn it back on.

LEDs in the memory, or the fold type buttons will light to indicate the last setting.

9.0 SETUP

Important note:

The operator control panel contains a numerical keypad, which is automatically activated when a function requires numerical data. The operator panel is color coded to show this relationship. Numerical data is required for

Sheet length

Two pieces of information are required to setup a job, assuming that initialization has previously been accomplished; sheet length and fold type. Either order may be used. Select the fold type first or the sheet length first

Note: When entering sheet length data use the length of paper as it enters the 8 Page Unit.

9.1 Setup for a standard fold

Method 1: Picking fold type first:

To setup for a new fold, press a **fold type** button. For example, to set a “Z” fold, press the “Z” fold button. The display will show the last job sheet length. If the sheet length is not correct, you will have 5 seconds to begin keying in the new sheet length and press the “ENTER” button (see figure 1). If the sheet length is correct, you may press the “ENTER” button and not wait 5 seconds before proceeding.

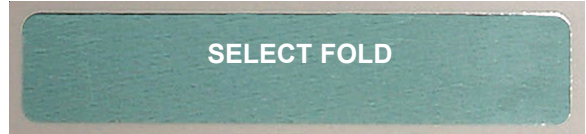
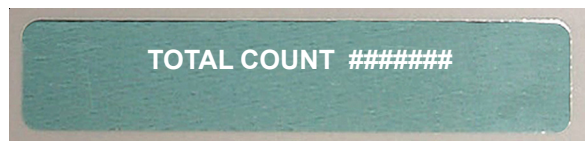
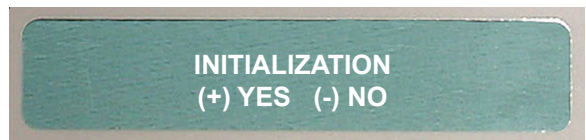
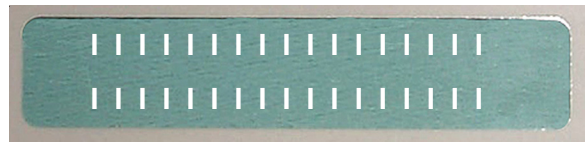
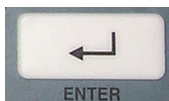

When the “ENTER” button is pressed, the fold plates and stacker will move to their new position. While the fold plate motor(s) are running, a **PLEASE WAIT** message will be displayed.



When the motors have stopped, one of two screens will be displayed.

If the sheet length data was changed, the **single sheet mode** screen is displayed.

If the sheet length data was not changed, the **count screen** will be displayed.

Method 2: Entering Sheet Length first:

Setup a new job by pressing the “SHEET MODE” button. The **Sheet Length** screen will be displayed showing the last set sheet length. You have the following options:

- 1.) Enter a new sheet length.



Note: Pressing the enter button will accept the new data and eliminate any waiting time before moving to the next function.

After 5 seconds the data will be accepted and the last fold type indicator will start flashing. Select the desired **fold type** by pressing the appropriate “**FOLD TYPE**” button. After 5 seconds the selection will be accepted and the fold plate stops will move to their new position. During this period the “**PLEASE WAIT**” screen will be displayed. When the folder has completed its movement, the count screen will be displayed.

If the count screen is not displayed press the “**SHEET MODE**” button to return to the **production mode**. The count screen will be displayed.



Accept the displayed sheet length by pressing the “**ENTER**” button.

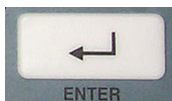

- 2.) Do nothing.
After 5 seconds, the count screen will be displayed.

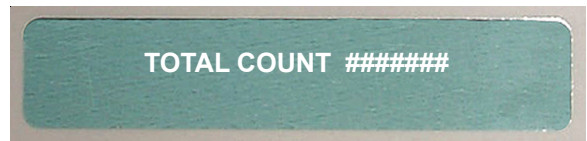
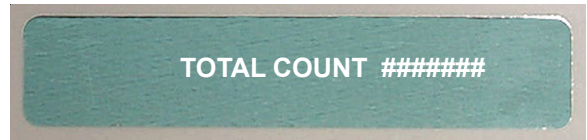

9.2 Setting up a special fold.

This machine has 3 memory locations that can be used to store special fold settings. These will store the plate settings, the stacker wheel location, and the speed setting for a fold.

9.2.1 To save a nonstandard fold in a memory location 3

Set up the fold as you normally would. Once the speed and folds are set the way you want, press a **“MEMORY SET”** button. Recall will appear in the display. Press the (-) button to get to the **STORAGE** screen.

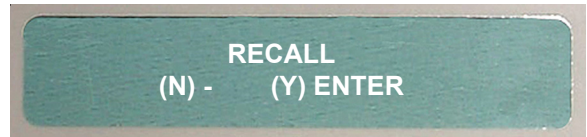
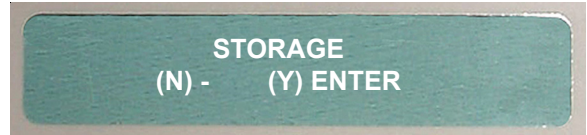
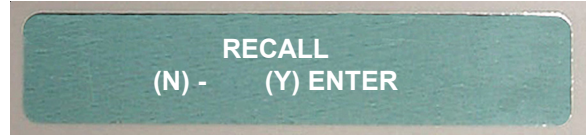
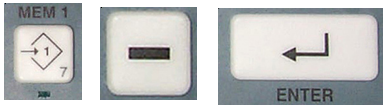

9.2.2 Recall a fold saved in memory location.

Press the **“MEMORY SET”** button that corresponds to the memory location you wish to recall. **RECALL** will appear. Press the **ENTER** button.

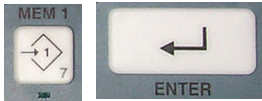

9.3 Continued

9.3 Starting Production:

After the **sheet length** and the **fold type** has been selected, production is started by:

Starting the main drive (press **“DRIVE”**),



The 8 Page Drive must be started first then the Parallel unit. The Parallel Unit will not start if the 8 Page Unit is not running.

“ENTER” button or press the correct **“FOLD TYPE”** button, then the **“ENTER”** button.



After every new set up the machine speed will always be reset to 60%.

The fold type status LED, when lit constantly, indicates that the fold plates are set for this type of fold.

Notes:

If the wrong **“FOLD TYPE”** button is pressed, you can either press the **“RESET”** button instead of the

Any time the folder is running and a change is made that causes the fold plate stops to move; the main drive will stop.

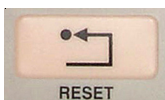

10.0 COUNTER OPERATION

During normal operation, the display should show the total count (maximum count 9,999,999), This display is known as the count screen.

10.1 Resetting the total count

To reset the total count press the “RESET” button, then press the “COUNT” button.



10.2 Rate

The “RATE” button is used to display the average pieces per hour, both current and average since the last total counter reset.

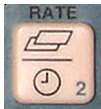

Pressing the “RATE” button will change the display to the rate screen consisting of two lines. The top line is the current rate. It will have a 5 digit display, and will refresh every 6 seconds. The second line will show the average pieces per hour since the last total counter reset. This line will also have a 5 digit display, and refresh every 30 seconds.

The display will stay in this mode until another mode button is pressed. The “ENTER” and “RESET” buttons will have no affect in this mode.

NOTE: Every time the total count is reset the average rate per hour will also be reset.

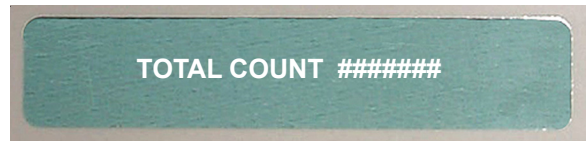

NOTE: If a button is not pressed within 2 minutes the machine will return to the operating mode.

11.0 FOLDER OPERATION

11.1 Time

The “**TIME**” button will display the time since the last total count reset and the total hours that the main drive has been on, the customer can not reset this meter.



Both hour meters will increment only when the folder is running. The main power will have no affect on these meters.

NOTE: Every time the total count is reset the job run time should also be reset.

Pressing the “**TIME**” button will change the display to the time mode. In this mode the first line of the display will show job run time and have a 4 digit capability to show the number of hours since last reset. The second line will show total hours and have a 6 digit capability to show the total hours on the machine.

The “**COUNT**” button can be used to go back into the count screen from the rate or time screen.



11.2 START/STOP button

In the normal operating mode pressing the “**START/STOP**” button will activate the main drive motor and the LED in the button will come on. Pressing the “**START/STOP**” button again will deactivate the main drive motor and turn off the LED.

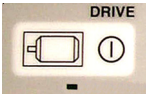

NOTE: If a button is not pressed within 2 minutes the machine will return to the operating mode.

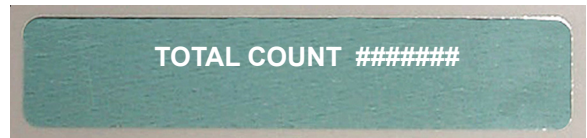

11.3 Speed

The speed of the machine can be changed by pressing the “SPEED” button while the main drive motor is running or stopped.

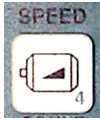

Using the “+” and “-” buttons, to adjust the speed.



The “+” button will increase the speed gradually, as long as the button is depressed. Once the folder reaches it's maximum speed a message will be displayed until the **ENTER** button is pressed.



The “-” button will decrease the speed gradually, as long as the button is depressed.



Once the folder reaches it's minimum speed a message will be displayed until the “ENTER” button is pressed.



Full speed range travel of the motor takes 10 seconds. Press the “ENTER” button to return to normal operation.

11.4 Fold Plates

The fold plate can be set at any time from the operating mode by pressing the “PLATE” button that corresponds to the fold plate which needs to be adjusted.

For example if you need to make an adjustment to the number 2 fold plate you would press the “PLATE 2” button.



Next use the “+” and “-” buttons to move the stop into position. Once either button is pressed the display will change to display the actual location of the plate stop.



NOTE: If a button is not pressed within 2 minutes the machine will return to the operating mode.

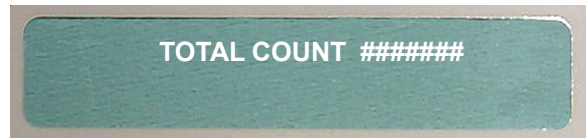
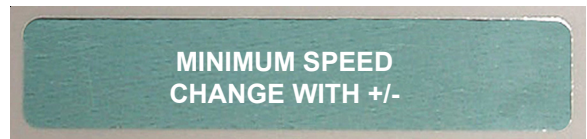

Pressing the “+” button once will increment the plate stop .010". Holding it down for more than 2 seconds will increment the plate stop continuously at slow speed. Holding the “+” button down for more than 5 seconds will increment the plate stop continuously at high speed until you release the button or the plate stop hits the home position switch.



Pressing the “-” button once will decrement the plate stop position .010". Holding it down for more than 2 seconds will decrement the plate stop position at slow speed. Holding the “-” button down for more than 5 seconds will decrement the plate stop position at high speed until you release the button, or the plate stop hits the deflect position switch.



Pressing the “ENTER” button will return you to normal operation.



11.5 Stacker wheels

The stacker wheels can be set at any time from the operating mode by pressing the “STACKER” button.



For example if you need to make an adjustment to the stacker wheels, press the “STACKER” button during operation.



Next use the “+” and “-” buttons to move the stacker wheels into position.

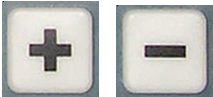

Pressing the “+” button will increment the stacker wheels continuously at slow speed. Holding the “+” button down for more than 2 seconds will increment the stacker wheels continuously at high speed until you release the button, or the stacker wheels reach their outer limit. The system will track the stacker wheel location and if they reach the stop, the drive will be disabled and a message will be displayed for 5 seconds after the “+” is released.



NOTE: To change from English to Metric, press the “U/M” button. Now all the dimensions will be in metric. This setting will remain until this procedure is repeated.

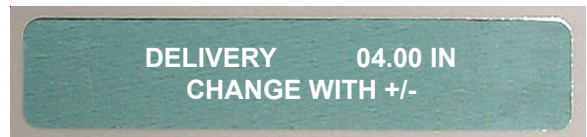
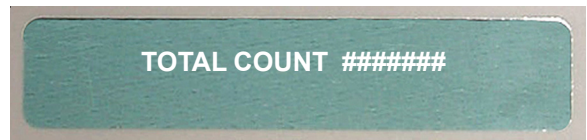

NOTE: If a button is not pressed within 2 minutes the machine will return to the operating mode.



Pressing the “-” button will decrement the stacker wheels position at slow speed. Holding the “-” button down for more than 2 seconds will decrement the stacker wheels position at high speed until you release the button or the stacker wheels hit the home position. Once the stacker wheels have reached the home switch the drive is disabled and a message will be displayed for 5 seconds after the “-” is released.



After the stacker wheels are in position press the “ENTER” button. This will return you to the operating mode.



11.6 Paper Jams

Should a jam-up occur, the machine will shut off and display will indicate where the jam occurred. Anytime a jam indication is showing in the display you can press the “**STACKER**” button and the stacker wheels will move to the end of the table to make clearing any paper jammed in the machine easier. Try to determine the cause of the jam and correct it before pressing the “**RESET**” button. Pressing the “**RESET**” button will clear the jam message, return the stacker wheels to their original position and re-enable the drive.

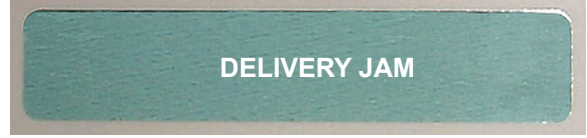
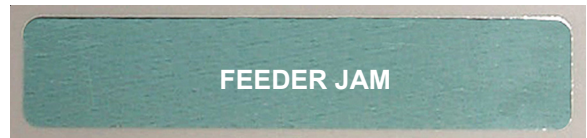
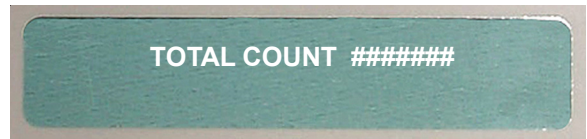
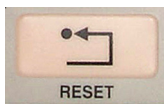
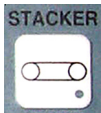

11.7 Shutting Off Jam Detectors

- 1) To enter jam detector mode, depress the “**SET JAM**” button:

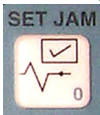

NOTE: Use the “+” button to toggle between enable and disable of the specific jam detector.



Use “-” button to make no change.



Display shows:

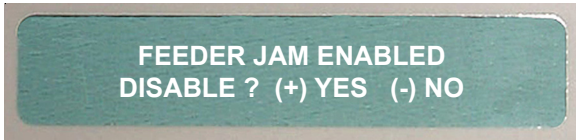

OR

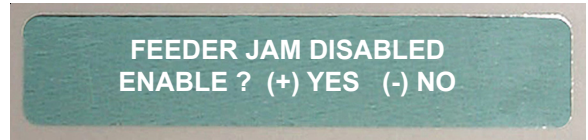

2) When the "+" or "-" button is depressed,



Display shows:

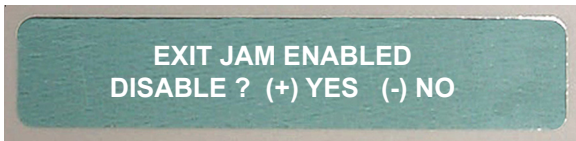

OR

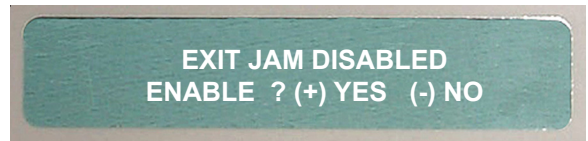

3) When the "+" or "-" button is depressed,



Display shows:

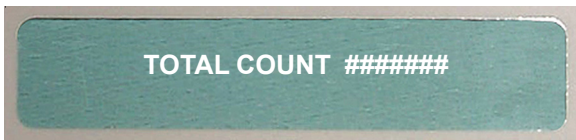

12.0 PERFORATING, SCORING & SLITTING

In addition to folding, your Flexifold 8 Page can perforate, score and slit.

WARNING

Unplug power supply before working on equipment.
Be careful when handling perforator and slitting blades. They are extremely sharp.

12.1 Perforating

The Flexifold can be used to perforate either the folded sheet (to assist in making a right-angle fold) or to perforate sheets delivered flat. BAUMFOLDER supplies one standard 41-tooth perforator blade. Additional perforator blades are available through the BAUMFOLDER Parts Department.

On the operator side of the folder there is a knurled knob beside the hand wheel. (See figure 12.1-1) This knob holds the slitter shaft assembly in place. Loosen the knob by turning counter-clockwise approximately 6 full turns.

Slitter Shaft Knob

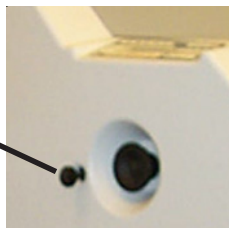

Figure 12.1-1

Pull the knob toward you, leaving about 1 5/8" gap at the right end of the slitter shafts. This gap permits the removal and installation of the slitter shaft accessories.

Loosen the setscrews (Item 1, Figure 12.1-2) in the pullout tire assemblies on the right end of the upper and lower shafts and remove the pullout tire assemblies.

The perforator blade, sharp surface down, should be mounted loosely to the blade holder collar. (Item 2 & 3, Figure 12.1-2) Always be sure that the flat side of the blade is against the blade holder. Loosen the brass-tipped set screws (Item 4, Figure 12.1-2) in the blade holder before attempting to place them on the slitter shafts.

The perforating blade holder assembly is then slid onto the upper slitter shaft. Tighten the screws (Item 5, Figure 12.1-2) holding the perforator blade to the blade holder, aligning the blade to the shaft. This allows for free horizontal movement on the shaft.

Slide the grooved perforator collar onto the lower slitter shaft. The flat side of the perforator blade should just touch the side of the groove in the perforator collar. (Item 6,

Figure 12.1-2)

Slide the perforator collar and blade holder to the desired position on the slitter shaft. Re-install the pullout tire assemblies on the right end of the upper and lower shafts.

Lock the slitter shafts in place by pushing in the knob as you align the slitter shafts with the slitter shaft journal assembly. Tighten the knurled knob. Then lock the blade holder and perforator collar into position with the brass-tipped set screw. (Item 4, Figure 12.1-2) Lock the pullout tire assemblies in place by tightening the brass tipped set screws. (Item 1, Figure 12.1-2)

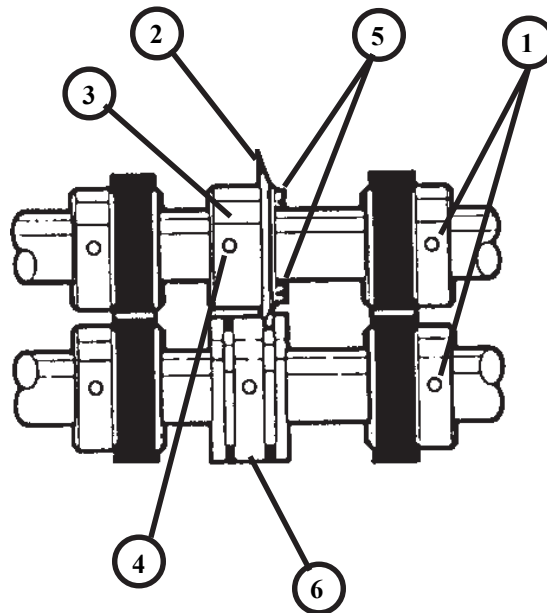

Figure 12.1-2

The perforator stripper fits onto spreader bar above the slitter shaft assembly and next to the perforating blade. (See Figure 12.1-3) This strips the paper off for delivery and prevents it from wrapping around the perforator blade.

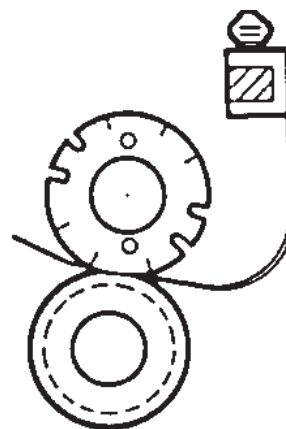

Figure 12.1-3

12.2 Scoring

The Flexifold can be used to score a sheet and deliver it flat, or to score a sheet after a fold or folds have been made.

To ensure accuracy in making right-angle folds, always score the sheet where the fold is to be made. This applies in all instances when a perforator cannot be used.

Access and installation to the slitter shaft assembly is the same procedure as described in the previous section on slitting.

Attach the scoring blade loosely to the blade holder for mounting on the slitter shaft. Scoring blades can be mounted on either the upper or lower slitter shaft. Once on the shaft, tighten the screws, aligning both the blade and the collar. This allows free horizontal movement on the shaft. Scoring blades should be placed so that the fold will be made with rather than against the scoring, or, in a continuing direction to the pressure of the crease that has been applied by the scoring blade.

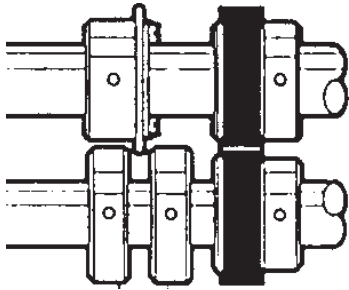

Figure 12.2-1

For a wide, well-rounded score, use the two steel scoring collars. (See Figure 12.2-1) Sharpness and the depth of the score can be controlled by regulating the distance the collars are placed away from the scoring blade.

The scoring collars can also be placed on either side of the rubber scoring collar. The two collars can be compressed against the rubber collar, causing the rubber to bulge up for a deeper score. (See Figure 12.2-2)

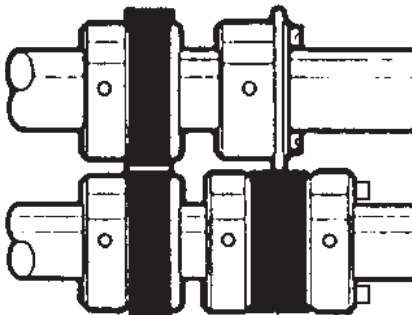

Figure 12.2-2

12.3 Slitting

NOTE: Slitting accessories are optional on your Flexifold and can be ordered from your BAUMFOLDER Parts Department.

The Flexifold can be used to cut folded or flat sheets apart. The general setup for blades and collars is shown in (Figure 12.3.1). Two or more cuts may be made if duplicate sets of cutters are used.

Use care in mounting slitter blades to the collars in order to avoid ragged edges during slitting operations. Ragged edges can be caused by two conditions:

1) Nicks or burrs on the collars or blades. Remove carefully by filing or using a fine piece of emery cloth.

2) Incorrect mounting of blades caused by tightening with the wrong type of screw. Always use flat head screws on the side of the blade and blade holder collar, which are countersunk.

Before tightening the blade to the collar, slide the blade with the collar loosely attached on the end of the shaft. Then tighten securely, thus aligning both the blade and collar, allowing free horizontal movement along the shaft.

Place the blade, mounted on the collar, on the upper shaft in the proper position where the cut is to be made. Then move the blade and collar on the lower shaft so that the two flat edges of the blades are pressed snugly together. Too much space between the blades will produce a ragged cut.

Space the rubber pull-out tires to support the sheet.

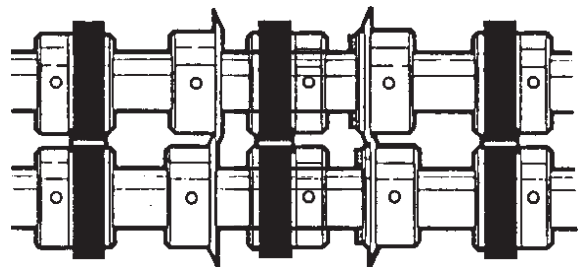

Figure 12.3-1

13.0 MAINTENANCE

13.1 Maintenance and Care of your 814MF

The Flexifold Air Feed has been designed to give you years of useful service, provided you maintain it according to these instructions.

13.2 Cleaning of Fold Rolls

Periodically wipe off the rubber surface of the fold rolls using an approved solvent such as Surewash or its equivalent. Surewash is available from BAUMFOLDER in 1-quart (P/N 24108-001) and 1-gallon (P/N 24108-002) containers. A complementary bottle of Surewash is included with your machine.

13.3 Cleaning Filters

The filters on the pump should be checked periodically and cleaned as needed. The filters can be reached by unscrewing the filter jars.

13.4 Photo Eyes

Occasionally wipe off both photo eyes with a dry cloth.

13.5 Cleaning The Fold Stop Guides

The fold stop guides should be cleaned once a week with a dry cloth to keep the plate moving properly.

13.6 Replacement Parts

To order replacement parts for your Flexifold Air Feed, contact BAUMFOLDER Parts Department toll free, **800-543-6107**.

Always be sure to give the model number and serial number of your Flexifold to ensure receiving the proper parts.

14.0 LANGUAGE SELECTION

Switch location, on the electronic board, for language and voltage selection settings.

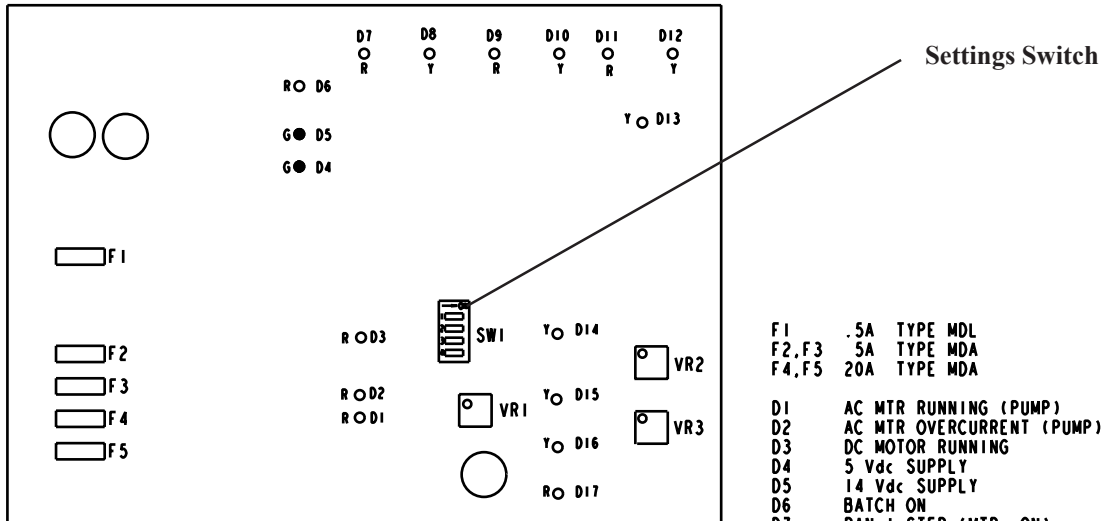

SW1 SWITCH SETTINGS

SW	1	2	3	4	FUNCTION
I	I	X	X		LANGUAGE-ENGLISH
O	I	X	X		LANGUAGE-GERMANY
O	O	X	X		LANGUAGE-SPANISH
I	O	X	X		LANGUAGE-FRENCH
X	X	I	X		115 VOLT PROGRAM
X	X	O	X		220 VOLT PROGRAM
X	X	X	O		MICROPROCESSOR CONTROL
X	X	X	I		MANUAL OVERRIDE
					FOLDER RUNS WITHOUT PROGRAM

SW LEGEND		
O	SWITCH OFF	
I	SWITCH ON	
X	DON'T CARE	

LED LEGEND

○	OFF
●	INITIALLY ON
G	GREEN
R	RED
Y	YELLOW

F1	.5A	TYPE MDL
F2,F3	.5A	TYPE MDA
F4,F5	20A	TYPE MDA

D1	AC MTR RUNNING (PUMP)
D2	AC MTR OVERCURRENT (PUMP)
D3	DC MOTOR RUNNING
D4	5 Vdc SUPPLY
D5	14 Vdc SUPPLY
D6	BATCH ON
D7	PAN 1 STEP (MTR. ON)
D8	PAN 1 LIMIT (PAN AT HOME POS.)
D9	PAN 2 STEP (MTR. ON)
D10	PAN 2 LIMIT (PAN AT HOME POS.)
D11	DELIVERY STEP (MTR. ON)
D12	DELIVERY LIMIT (PAN AT HOME POS.)
D13	TACHOMETER (PULSE INPUT)
D14	MANUAL OVERRIDE ENGAGED
D15	FEED SENSOR (UPPER JAM)
D16	DELIVERY SENSOR (LOWER JAM/COUNT)
D17	PILE INTERRUPT

VR1	FACTORY SETTING-AC MTR OVERLOAD
VR2	FEED SENSOR-FULL CW
VR3	DELIVERY SENSOR-FULL CW

15.0 DISPLAY MESSAGES

The following are other display messages that may appear.

KEYBOARD MISSING

BAD KEYBOARD

FOLDER OVERLOAD
PRESS RESET

NO TACH. CHECK
MOTOR, BELTS, ENCODER

CHANGE +/-

PLATE NO.

HOME NOT REACHED
PRESS RESET

OUT OF RANGE

PAPER SIZE INCORRECT
PRESS RESET

INSTALL DELIVERY
OR PRESS RESET

INSTALL PLATE NO.1
OR PRESS RESET

INSTALL PLATE NO.2
OR PRESS RESET

PAN 1 STOP 05.00 IN
CHANGE WITH +/-

SUREWASH
16.0 MATERIAL SAFETY DATA
SHEET

NOTICE: Surewash is a product of RBP Chemical Corporation, 150 S. 118th St., P.O. Box 14069, Milwaukee, Wisconsin 53214-0069. Tel. 414/258-0911, 800/558-0747.

H M I S RATING

Health: 1
Flammability: 2
Reactivity: 0
Personal Protection: 8

HAZARDOUS INGREDIENTS

Name: Medium Aliphatic Solvent Naptha
(Syn: 140 HF Mineral Spirits)
CAS#: 64742-88-7
ACGIH TLV: 100ppm
OSHA PEL: 500ppm
%: <95

PHYSICAL/CHEMICAL CHARACTERISTICS

Boiling Point: ND
Solubility in Water: Insoluble
% Volatiles (by vol.): 95
Specific Gravity: 0.786
Appearance and Odor: Clear, light blue liquid with pleasant odor.

FIRE AND EXPLOSION HAZARD DATA

Flash Point: 140° F
Extinguishing Media: CO2, Dry chemical,
Foam
Special Fire Fighting Procedures: Wear self-contained breathing apparatus for any fire involving chemicals.
Unusual Fire and Explosion Hazards: None

REACTIVITY DATA

Stability: Stable
Incompatibility: Strong oxidizers
Hazardous Decomposition By-products: Carbon dioxide/monoxide
Hazardous Polymerization: Will not occur
Conditions to Avoid: Heat, Sparks, and Open Flames

HEALTH HAZARD DATA

Routes of Entry: Inhalation, Primary; Skin, Secondary; Ingestion, Unlikely
Health Hazards Acute and Chronic: Chronic

Inhalation of high concentrations may cause respiratory tract irritation and may affect central nervous system. May cause skin irritation. Chronic over-exposure to many petroleum hydrocarbons may cause liver or kidney injury. May cause eye irritation.

Emergency & First Aid Prodedures:

Skin Contact: Wash affected area with soap and water. Remove contaminated clothing.

Eye contact: Flush eyes with water for at least 15 minutes. Consult a physician.

Inhalation: Remove to fresh air. Restore breathing if required. Get medical attention.

Ingestion: DO NOT induce vomiting. Get medical attention.

Carcinogenicity: None of the ingredients in this product are listed by IARC, NTP, or OSHA as carcinogenic.

Signs and Symptoms of Over-exposure: Headache, dizziness, nausea, irritation of the mucous membranes, respiratory tract irritation or mild narcosis at high concentrations.

Medical Conditions Aggravated by Exposure: May aggravate an existing dermatitis.

PRECAUTIONS FOR USE AND DISPOSAL

Spills: Small spills can be soaked up with suitable absorbent. For large spills, dike the spill and pump to salvage tank.

Waste Disposal: Incineration or absorbent disposal according to local, state, or federal regulations.

Special Storage/Handling Precautions: None

CONTROL MEASURES

Respiratory Protection: Organic vapor respirator for concentrations above the TLV.

Ventilation: Mechanical

Eye Protection: Recommended

Gloves: Recommended, butyl, rubber or neoprene.

Other: Eye bath or safety shower should be located in the work place when working with chemicals.

*ND = No data found or not determined.

The information contained herein is furnished without warranty of any kind. Users should consider this data a supplement to other information gathered by them and are responsible for completeness of information to assure proper use of these materials and the safety and health of their employees.

To order Surewash call toll free, 800/543-6107
Part numbers: 24108-001 (quart) & 24108-002 (gallon)

17.0 BASIC THEORY OF BUCKLE FOLDING

If a sheet of paper is laid on a flat surface and driven into a stationary object, a buckle or series of buckles will form along the surface of the sheet.

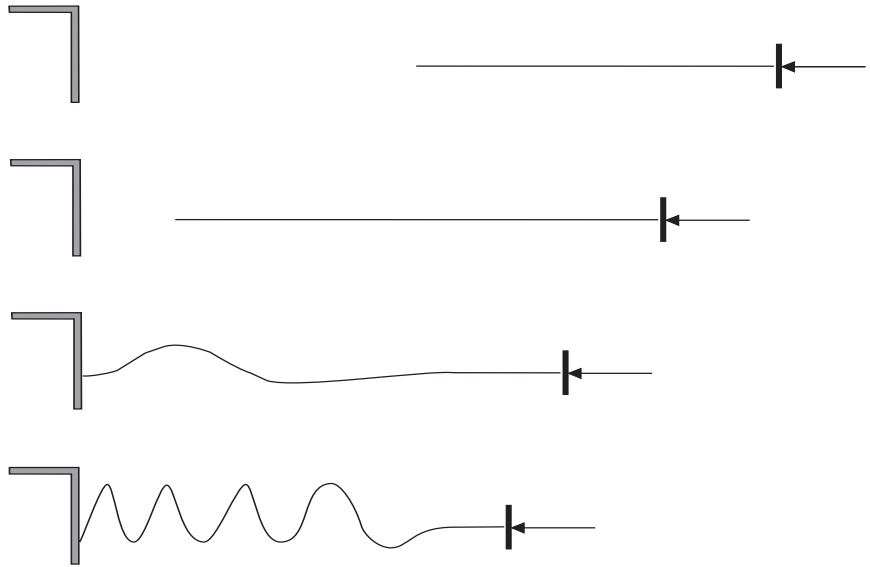

If the sheet of paper is pushed into a narrow channel before butting up against the stationary object, the buckles that form within the channel will be of a much smaller size than free-forming buckles. At the end of the channel, however, larger buckles will again start to form.

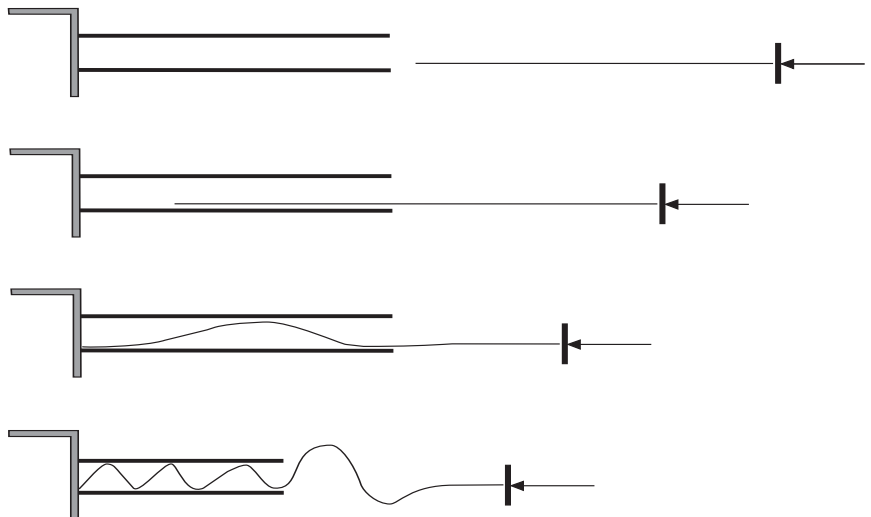

If the channel is angled to produce a downward pressure, and two folding rollers, spinning as indicated, are placed close to the end of the channel, the larger buckles that start forming there will always be formed downward and be pulled into the rollers, compressing into a fold.

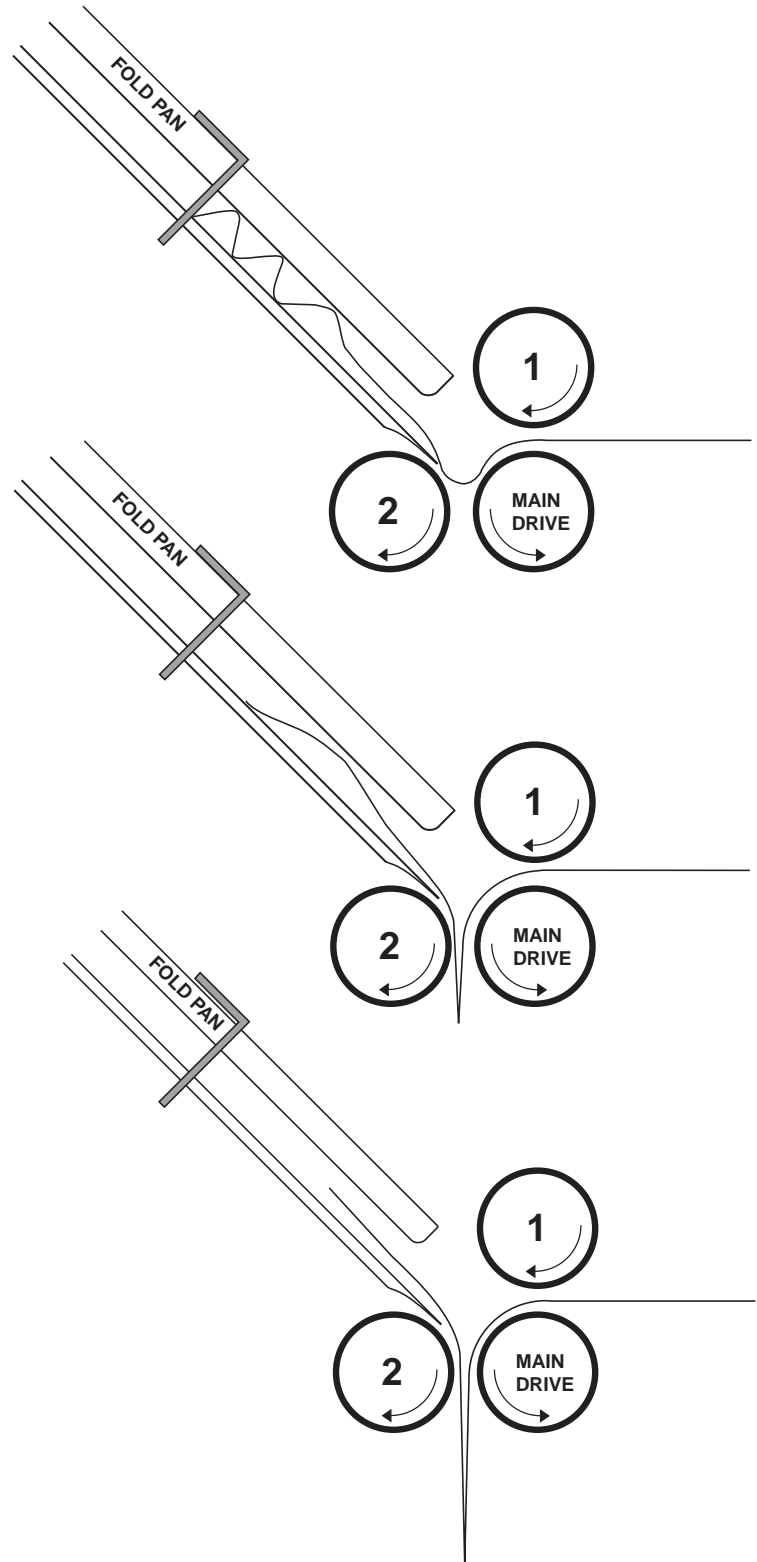

On a buckle folder, the sheet is laid flat on a feed table and then enters the fold plate assembly where it comes to a stop against the stationary sheet stop. A series of buckles throughout the sheet. The buckles within the fold plate are kept very small by the narrow channel design. The buckles at the end of the fold plate, however, will be larger. The fold plates and fold rollers are configured such that the large buckle will always form downward, where it can be grabbed by the fold rollers and compressed into a fold.

Look at figure 1. You can see that fold plate #1 is angled upwards. Because of this and the configuration of the fold rollers, sheets fed into the #1 plate will always be folded up (i.e. so that the “up” surface of the sheet is folded into contact with itself).

Likewise, because fold plate #2 is angled down, sheets fed into it will be down-folds; the “down” surface of the sheet will be folded into contact with itself. The picture shows the plate #2 deflector in position. The sheet does not enter plate #2, deflected, producing a single fold.

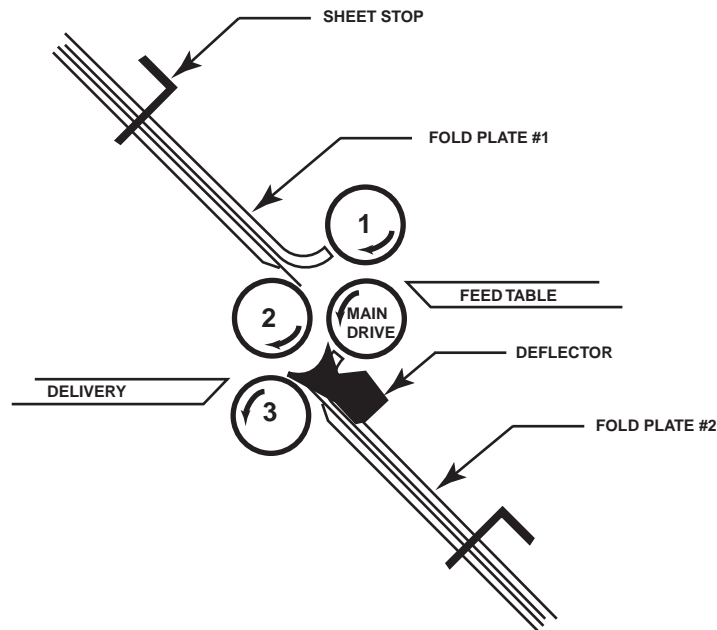

FIGURE 1

Fold Pan
#1
#2

Fold
UP
DOWN